



# Boston Shearpump<sup>®</sup>

*Inline, High Volume Mixing and Texturizing of Viscous Slurries*

## The only shearpump with high throughput & adjustable shear capability

The Boston Shearpump is comparable to other shearpumps with the distinct advantage of substantially higher throughput and moderate to high shear rates, all provided within a 3-A (#36-01) compliant, easy to clean-in-place design. The Admix Boston Shearpump is ideal for mixing solids or powders into viscous liquids that typical high shear mixers cannot handle. The Admix Boston Shearpump also has an excellent history of solving special mixing requirements where "texturizing" of high solids is required, such as refried beans, cream cheese, salsa, processed cheese slices, mashed potatoes, pharmaceutical preps, polymers, detergents and more. Where conventional shearpumps are only capable of 30 GPM, the Boston Shearpump is available in two models for a flow range from 10 to 150 GPM.

## Multiple specific purpose shear heads provide ultimate flexibility

- Standard shear head grades include coarse, medium, and fine
- Special purpose heads available for texturizing and blending without damaging or altering solids and desired consistency



## The Boston Shearpump BSP 24C and 60C

The Boston Shearpump is compact, rugged, and powerful... and designed for dispersing hard-to-wet-out powders and solids that conventional inline mixers cannot effectively process. Two sizes are available with a compact footprint and casters for mobility if desired. The Boston Shearpump is built to last with fully machined, heavy-walled housings, and shear heads with totally closed slots for maximum endurance. It's also extremely easy to disassemble for inspection or cleaning, or may be cleaned in place, with every step of the design process guided by the newest 3-A TPV specifications under Standard #36-01. The close clearance rotor and stator head running at high tip speeds with a production range from 10 to 150 GPM ensures a powerful performance for multiple applications.

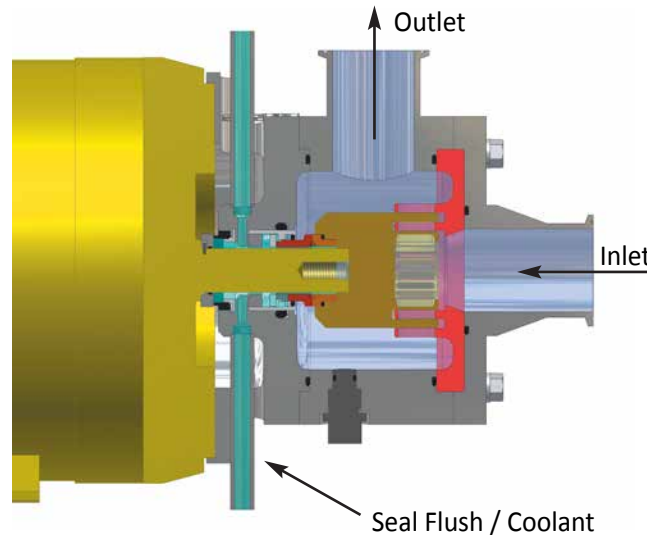

### Standard Models & Specifications

Model	Tip Speed	Throughput	Motor / Speed	Fittings	Weight (lbs)	Dimension (inches)					
						A	B	C	D	E	F
BSP 24C	41 FPS (12.5 MPS)	10-30 GPM	7.5 HP@3600 RPM	2" In/2" Out	250#	25	10	14	13.5	10.3	20
BSP 60C	41 FPS (12.5 MPS)	30-150 GPM	40 HP@3600 RPM	3" In/2" Out	550#	38	14	22	20	16.5	42

Specifications shown are standard. Customizations available.

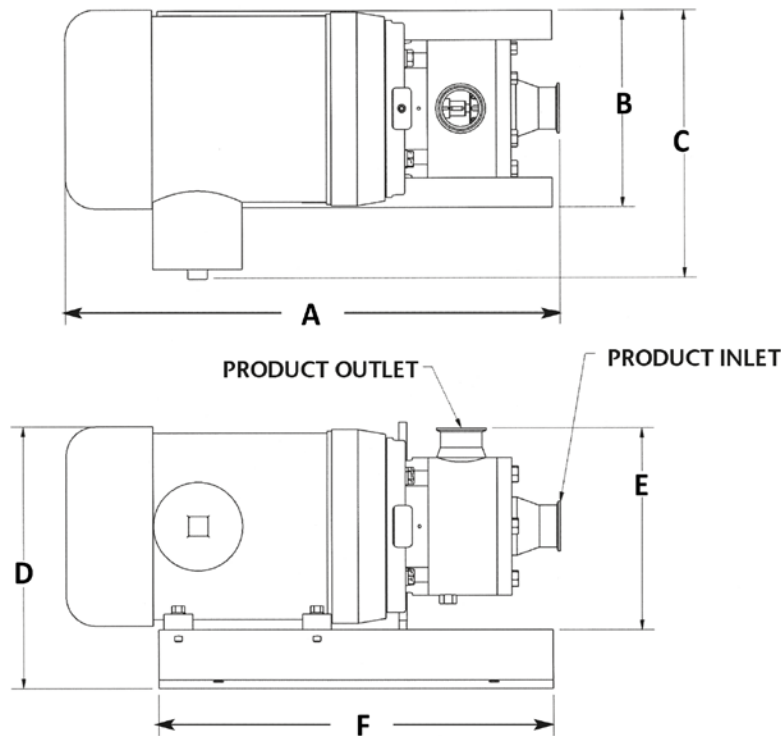

## Design Technology and features

The two key design components that distinguish and elevate the Boston Shearpump from all competitive shearpumps and inline mixers are the shear heads and the mechanical seal.

**Shear Heads:** The double ring design of each head (rotor and stator) provides two stages of mixing. The process fluid will pass through the 1st set of rotor slots, through the 1st ring of slots on the stator, and further through the 2nd ring of slots in both the rotor and stator. This results in 3 distinct high intensity work zones.

### Shear Head Options:

- Coarse
- Medium
- Fine
- Very Fine
- Ultra
- Salsa
- Ripper
- Specialty Designs

**Mechanical Seal:** All Boston Shearpumps feature a unique single mechanical seal with a pressure rating of 700 PSI. This feature allows the operator to optimize both operating pressure and backpressure to fine tune the flow & mixing characteristics of the emulsified or milled product. A second seal is used to contain a low-pressure seal flush, for both cooling and flushing of the seal.

**SafeUnit Pressure & Flow Regulator:** Our SafeUnit flow meter allows the operator to regulate both the seal quench flow rate and line pressure to

reduce seal maintenance and promote long seal life.

